



SanDisk Sansa™ e200



User Guide

Table of Contents

Safety Instructions	4
Introduction	5
Package Contents	6
Getting Started	7
Overview Of Features	7
Music Screen Features	8
Playback Screen Features	9
Li-ion Battery Charge	9
Battery Level Indicator	10
Battery Replacement	10
Battery Warning	10
Do not disassemble, crush, short-circuit or incinerate as it may cause fire, injury, burns or other hazards	10
Hold Switch	11
Minimum System Requirements	11
Connecting and Transferring	11
Connect to your computer	11
Sansa Media Converter	12
Supported IMPORT media types	13
Transfer Photos and Video	13
Transfer Music	14
Delete Files	14
Synchronize Files	14
Various software packages are available to synchronize songs on your device. Please refer to the specific software package instructions	14
Safely Removing Sansa e200 from you Computer	14
Basic Usage	15
Power On	15
Using Thumbwheel	15
Main Menu	16
Using Navigation Buttons	16
Using Submenu Button	16
Power Off	17
Music Mode	18
▪ Music/Voice/FM Playback	18

▪ Setting Repeat Mode.....	18
▪ Setting Shuffle Mode.....	19
▪ Setting Music EQ.....	19
▪ Add songs to Playlist.....	20
▪ Remove Songs from Playlist.....	20
▪ Scan Through Song.....	21
▪ Rate This Song.....	22
Photo Mode.....	22
▪ Viewing Photos.....	22
Slideshow.....	23
▪ Slideshow Options.....	24
Video Mode.....	25
▪ Playing Video.....	25
FM Radio Mode.....	25
▪ FM Radio.....	25
▪ FM Preset.....	26
Recording Mode.....	27
▪ Voice Recording.....	27
▪ FM Radio Broadcast Recording.....	28
Settings Mode.....	29
▪ Set Backlight.....	29
▪ Set Language.....	30
▪ Set Date and Time.....	30
▪ Set Brightness.....	31
▪ Reset to Original Setting.....	31
▪ Device Information.....	31
▪ Set Auto Shut-Off.....	32
▪ Set USB Mode.....	32
▪ Reset the Device.....	32
Tips, FAQ, and Troubleshooting.....	33
Service and Warranty Information.....	35
Getting Technical Support.....	35
Learn More.....	35
Your 1-Year SanDisk Limited Warranty.....	36
End User License Agreement.....	39

Safety Instructions

1. **Read the safety instructions carefully before using your Sansa.**
2. Read this entire manual to ensure proper usage.
3. Keep this User Guide for future reference.
4. Do not use **HeadPhones/Earphones** while driving, cycling, or operating any motorized vehicle. This may create a traffic hazard and may be illegal in some areas. It can also be dangerous to play your music with **Headphones/Earphones** at high volume while walking, or engaged in other activities. You should exercise extreme caution and discontinue use in potentially hazardous situations.
5. Avoid using **Headphones/Earphones** at high volume. Hearing experts advise against continuous loud and extended music play. Keep the volume at a moderate level, so that you are better able to hear outside sound, and to be considerate of the people around you.
6. Keep your player away from sinks, drains, bathtubs, showers, rain, and other sources of moisture. Moisture can cause electric shocks with any electronic device.
7. Follow these tips to keep your player working well for a long time:
 - Clean your player with a soft lint-free cloth used on glass lenses.
 - Do not allow young children to use your player unsupervised.
 - Never force any connector into the ports of your player or your computer. Make sure your connectors are the identical shape and size before you connect.

Introduction

Congratulations on your purchase of a **SanDisk Sansa™ e200**.

The Sansa e200 is a high performance portable digital audio/video player with a build-in FM radio and a voice recorder. The Sansa e200 enables users to play MP3, WMA, and secure WMA audio files. It also plays video and shows photo files that are transferred to the player through the Sansa Media Converter. You can listen to FM radio broadcast, record voice and record FM radio broadcast.

The Sansa e200 provides superior sound playback and supports Microsoft PlaysForSure subscription music. The SanDisk Media Converter supports most image formats allowing you to enjoy photos and personal videos.

The Sansa e200 is available in the following capacity points:

2GB (e250), 4GB (e260), 6GB (e270)

		2GB	4GB	6GB
MP3	Hours of Music Content	32	64	96
	Number of Songs	500	1000	1500

Note: Approximation based on 4 minute songs at 128 kbps MP3 (3,932,160 bytes/song)

1 megabyte (MB) = 1 million bytes; 1 gigabyte (GB) = 1 billion bytes. Some of the listed capacity is used for formatting and other functions, and thus is not available for data storage.

Features:

- **Digital Audio Player** – supports MP3, WMA, and secure WMA, audio files. Other file types need to be converted to these formats.
- **Video Player** – supports video files transcoded and transferred to the device through the included Media Converter software.
- **Photo Browser** – supports photo files transcoded and transferred to the device through the included Media Converter software.
- **FM Radio** – includes an integrated FM radio for listening to live-broadcast FM radio stations.
- **Voice Recorder** – supports voice recording function with built-in microphone.
- **FM Radio Program Recording** – provides synchronous recording function for FM recorded files.
- **EQ effect** – you are able to select an EQ mode to personalize your music experience.
- **micro SD Slot** – supports read or write from external micro SD cards.
- **Internal Memory** – allows users to store data on the internal memory

Package Contents

Please unpack your **Sansa e200** and check that the following were included.

- Earphones
- USB 2.0 Travel Cable
- Driver Disk (User's Manual included)
- Quick Start Guide
- Travel Pouch
- Lanyard

Getting Started

Overview Of Features

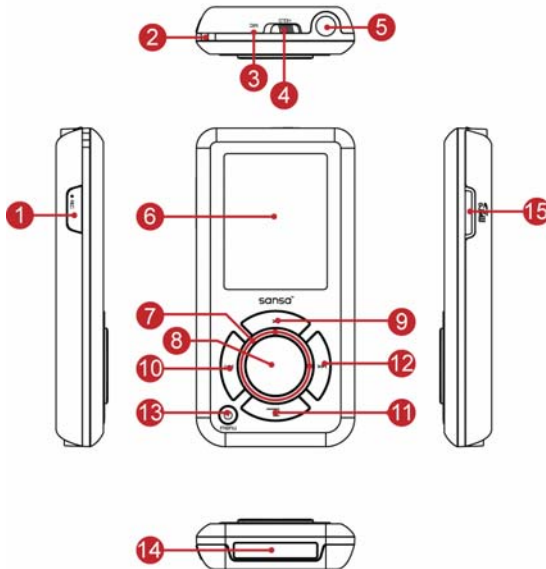

- | | |
|--------------------------|--|
| 1. Record | Voice Record Button. |
| 2. Strap Eyelet | Lanyard connection. |
| 3. MIC | Internal Microphone. |
| 4. Hold | Slide to lock (shows Orange Color) or unlock controls. |
| 5. Earphone Port | Connect earphones here to listen to player. |
| 6. Display Window | Read status and information here. |
| 7. Thumbwheel | Rotate to select menu items or adjust volume. |
| 8. Select Button | Press to select the item. |

- 9. **Up/Pause/Resume** Press to move up one item, pause, or resume.
- 10. **Left/Previous/Rewind** Press for previous track, rewind, or move left.
- 11. **Down/Submenu** Press to move down or to options menu.
- 12. **Right/Forward** Press for next track, fast forward, or move right.
- 13. **Power/Menu/Reset** Press to power on/off, enter menu, or hold 8 seconds to reset.
- 14. **Dock Connector Port** Plug the Dock Connector Cable here.
- 15. **micro SD Card Slot** Insert micro SD, SanDisk TrustedFlash™ and gruvi™ content cards for additional memory capacity.

Music Screen Features

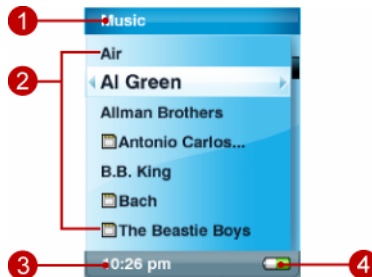

- 1. **Menu Title** Displays the title of the current menu.
- 2. **Items** Displays items for selection.
- 3. **Time** Indicates the current time.
- 4. **Battery** Indicates the Battery Charge Status.

Playback Screen Features



1. **Track Number** Display the current track number and the total number of sound tracks.
2. **Artist Name** Displays the current playback track artist name.
3. **Song Name** Displays the current playback track song name.
4. **Track Timer** Displays the timer of the current playback track.
5. **Clock** Displays current time.
6. **Repeat** Indicates when Repeat function is enabled.
7. **Album Name** Displays the album name of the current playback file.
8. **Play/Pause/Stop** Displays the music or voice files playback status.
9. **Track Length** Displays the length of current playback file.
10. **Battery** Indicates the Battery Status.

Li-ion Battery Charge

The Sansa e200 comes with a replaceable Li-ion rechargeable battery. To use the device for the very first time, remember to fully charge the Li-ion battery.

Follow the instructions below:

1. Connect the small connector of the USB Cable to the USB port on the computer, and then plug the larger end in to the Sansa e200 Dock Connector. The computer must be on for most USB ports to charge your

battery.

2. To stop recharging, disconnect the cable.

The Li-ion rechargeable battery will reach about 70% charge in 2.5 hours and full charge in about 3.5 hours. It is recommended that you fully charge your Sansa e200 before first use.

Note: Some low-power USB ports may not be able to provide enough charge power. Also note that rechargeable batteries may eventually need to be replaced as they have limited charge cycles (which vary with use and settings).

Battery Level Indicator

Battery is Half Full



Battery is Low



Battery Replacement

The Li-ion rechargeable battery is replaceable. To purchase a replacement battery see your local retailer or visit SanDisk.com. Follow the instructions provided with the replacement battery.

Battery Warning

Do not disassemble, crush, short-circuit or incinerate as it may cause fire, injury, burns or other hazards



CAUTION: *Do not disassemble, crush, short-circuit or incinerate your battery as it may cause fire, injury, burns or other hazards.*

Hold Switch

The Sansa e200 Hold Switch is located on the top of the device, and is used to prevent any accidental operation. Once the Hold Switch is moved to the lock position, all function keys will be disabled. Buttons on the Sansa e200 will not operate when the Hold Switch is active (Orange Color visible).

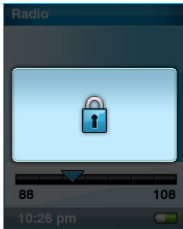

Minimum System Requirements

- Windows XP SP1
- Windows Media Player 10
- Intel Pentium class PC or higher
- CD-ROM drive
- USB 2.0 port required for hi-speed transfer

Connecting and Transferring

Connect to your computer

1. Connect the small USB Cable end to the computer USB port and plug the larger Cable Dock Connector to your **Sansa e200 port**.
2. The Sansa e200 will show connected and your computer will show the device as an additional drive called “Sansa e200”

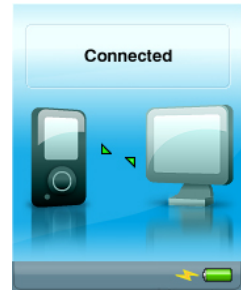

Sansa Media Converter

You will need to use Sansa Media Converter to transfer photos and video to your Sansa e200. Insert your SanDisk CD and select Sansa Media Converter to install it to your PC. Then you can load your personal photos and video onto your Sansa e200 by using Sansa Media Converter.

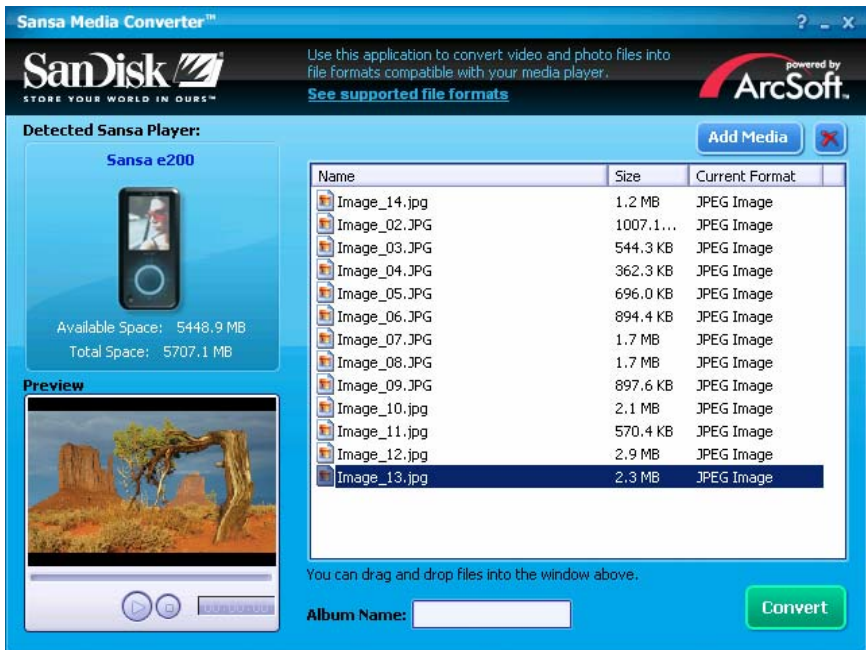

Sansa Media Converter™

SanDisk
STORE YOUR WORLD IN OURS™

Use this application to convert video and photo files into file formats compatible with your media player.
[See supported file formats](#)

powered by
ArcSoft

Detected Sansa Player:
Sansa e200

Available Space: 5448.9 MB
Total Space: 5707.1 MB

Preview

Name	Size	Current Format
Image_14.jpg	1.2 MB	JPEG Image
Image_02.JPG	1007.1...	JPEG Image
Image_03.JPG	544.3 KB	JPEG Image
Image_04.JPG	362.3 KB	JPEG Image
Image_05.JPG	696.0 KB	JPEG Image
Image_06.JPG	894.4 KB	JPEG Image
Image_07.JPG	1.7 MB	JPEG Image
Image_08.JPG	1.7 MB	JPEG Image
Image_09.JPG	897.6 KB	JPEG Image
Image_10.jpg	2.1 MB	JPEG Image
Image_11.jpg	570.4 KB	JPEG Image
Image_12.jpg	2.9 MB	JPEG Image
Image_13.jpg	2.3 MB	JPEG Image

You can drag and drop files into the window above.

Album Name:

Convert

Supported **IMPORT** media types

- Still Image Files: JPEG, TIFF, PNG, BMP, GIF.
- Video Files: AVI, MPEG-1 & MPEG-2 in MPEG, MPG, MPE or VOB(unprotected) formats. MPEG-4 in AVI format, DAT, ASF, QuickTime MOV, and WMV. Please Note: QuickTime 6.5 or higher and Windows Media Player 9 or 10.0 are required for QuickTime MOV file. Error message will appear if not installed.

Transfer Photos and Video

To transfer photos and video to your **Sansa e200**.

1. Open Sansa Media Converter on your PC
2. Connect **Sansa e200** to the computer.



The detected Sansa e200 will list the available space and total space on the device. If more than one device is inserted, only the first device will be supported.

3. Add the media files to be converted



4. Press  to start the conversion process and transcode all of the files in the selected media window and output them using the parameter setting for each media type. A convert status box will appear showing which file(s) are being converted.

Transfer Music

To transfer music to your **Sansa e200**.

1. Connect **Sansa e200** to the computer.
2. Drag and drop files from your computer to **Sansa e200** by using a variety of music software programs to transfer/synchronize your files.
3. In MTP mode as long as the files are WMA or MP3, they can be dragged into the Media folder. Otherwise, they can be dragged into the Data folder (these files will not appear on the player).
4. In MSC mode, files/folders can be dragged/copied to the device.

Delete Files



When your player is connected to your computer, use your operating system file browser to view all files on your player and to delete files.

Synchronize Files

Various software packages are available to synchronize songs on your device. Please refer to the specific software package instructions.

Safely Removing Sansa e200 from you Computer

After managing the files or updating firmware, follow these steps to safely remove the **Sansa e200**:

1. On the task bar, click on the MTP Media Player icon  in MTP mode
or the Safely Remove Hardware icon  in MSC mode.
2. Wait until "**Safe to Remove Hardware**" message is displayed.
3. You can now disconnect the player from the computer.

Basic Usage

Power On

Press the Power button once. The Thumbwheel will light up and the main menu will appear.

Using Thumbwheel

Turn the wheel **clockwise to scroll down** though menu items rapidly or increase the volume during playback.

Note: when you use the wheel the blue LED under the wheel should lighten automatically.

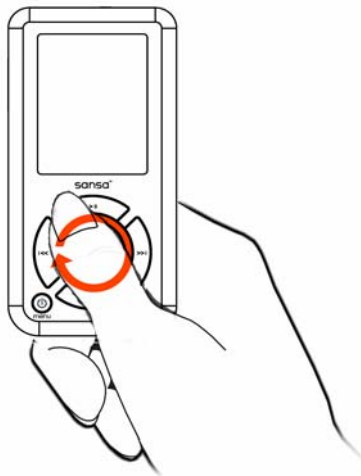

Turn the wheel counterclockwise to scroll up though menu items rapidly or decrease the volume during playback.

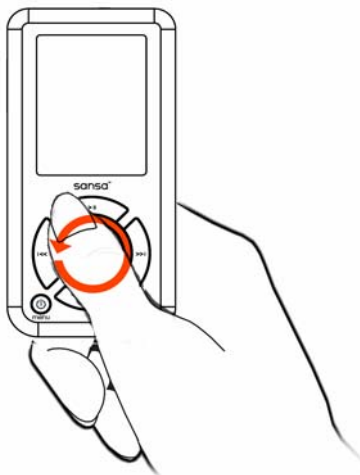



Main Menu

- Music
- FM Radio
- Photo
- Settings
- Voice
- Video

Using Navigation Buttons

Use Navigation Buttons, described in “Getting Started”, to navigate though menus, play music, play video, browse photos and arrange files.

Using Submenu Button

When submenu is available, the submenu icon  will display on the left bottom of the Sansa e200 screen. Press the Submenu  to enter submenu.

Power Off

Press the Power button and hold for two seconds or until “**Goodbye**” is displayed.

Music Mode

▪ Music/Voice/FM Playback

1. To play music stored in the internal memory or SD card, recorded FM or Voice recording, select **Music** in Main Menu.



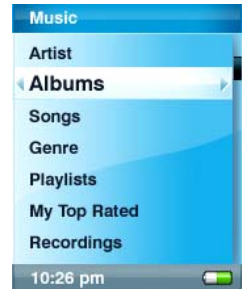

2. Select **Artists, Albums, Songs, Genres, Playlists, Recordings(FM/Voice), My Top Rated,** and **Music Options.**

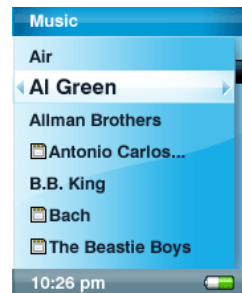

3. Highlight and Select the desired track or file to play. You can browse other areas of your player (music lists, settings, and photos), while your music is playing.



▪ Setting Repeat Mode

1. In playback mode, press submenu .
2. Highlight and Select **Repeat**.
3. Select one of the following:
 - **Off**: No repeat of tracks
 - **Song**: Repeat the current track
 - **All**: Repeat all selected tracks
- Press submenu  again to exit Music Options.

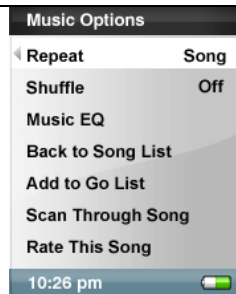

▪ Setting Shuffle Mode

1. In playback mode, press submenu .
2. Select the **Shuffle** item. To play songs in random order, set Shuffle to **On**.
3. Press Left arrow for previous screen.

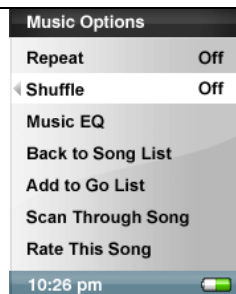

▪ Setting Music EQ

Sansa e200 provides various EQ modes, such as **Classical, Pop, and Rock**.

1. In playback mode, press submenu .
2. Scroll and Select the **Music EQ** item.

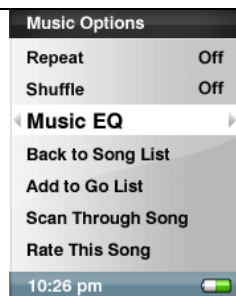

-
3. Scroll and Select a **Music EQ** mode.
 4. Press the Left Arrow to return to Music Menu.
-

▪ Add songs to Playlist

1. Play a song.

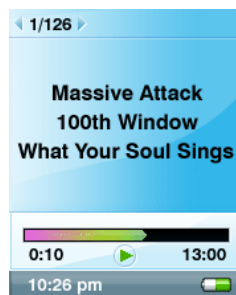

2. In playback mode, press submenu  .
3. Select the **Add to Go List**.

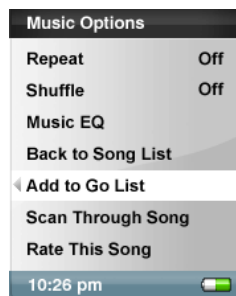

▪ Remove Songs from Playlist

-
1. Select Playlist and play a song.
 2. In playback mode, press submenu  .
 3. Select the **Remove Song from Go List**.

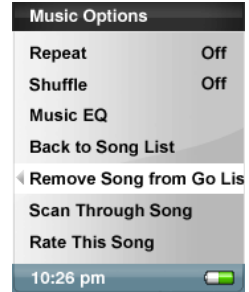

• Scan Through Song

1. In playback mode, enter submenu.
2. Select the **Scan Through Song** item.
3. Use the Thumbwheel to scan the song.
4. **3 seconds of inactivity exists Scan mode.**
5. Press the Left Arrow for previous menu.

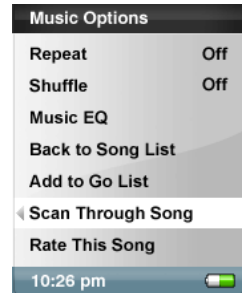

▪ Rate This Song

1. In playback mode, press submenu  .
2. Select the **Rate This Song** item.

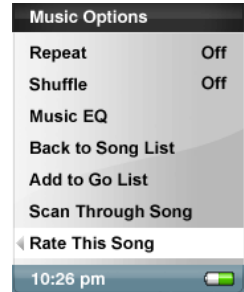

3. Use Thumbwheel to rate the song (1 to 5 stars) and press left arrow button to exit back to Music Options menu. My Top Rated Songs can be viewed in MUSIC menu.

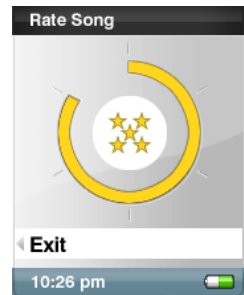

Photo Mode

▪ Viewing Photos

-
1. To view photos stored on the internal memory or micro SD card, select **Photo** in the main menu.



-
2. Select **PhotoList** or **Thumbnails**.

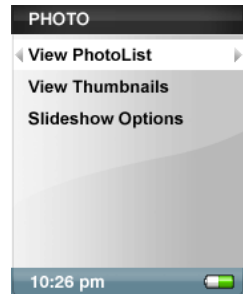

-
3. If you selected Thumbnails you will see the browser screen. Scroll through the photos and select the one of interest.
 4. Use the right/left buttons to advance or backup to another photo.



Slideshow

To play slideshow, Press Select button while viewing photos. You can set how long each image is displayed in **Setting Slide Interval**.

• Slideshow Options

1. Select **Slideshow Options** in **PHOTO** menu.

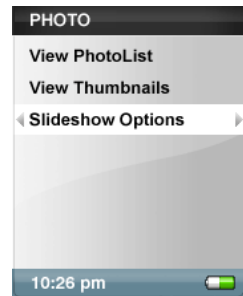

2. Personalize your **Slideshow Options**.

- Select the **Shuffle:** **On** for random order.
- Select **Loop:** **On** to set nonstop slideshow.
- Select the **Slide time** each photo view time.
- Select the **Music** for background music and select **CurrentSong** or **Golist** in the Music submenu.

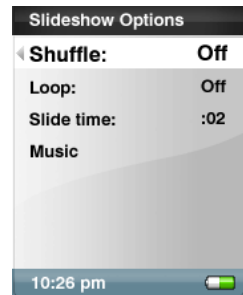

3. Press Left Arrow to move to **Photo** menu.
4. Select **ViewPhotoList**
5. Select the Photo folder you desire.
6. Select the first picture of your slideshow.
7. Press Select to start and pause the show.
8. Use Thumbwheel to control volume.
9. Press submenu  to go back to

ViewPhotoList.

Video Mode

• Playing Video

1. To play video stored on the internal memory or SD card, select **Video** in Main Menu.



2. Select a **Video** to play.
 3. Press Select to pause or resume the video.
 4. Press and hold Right Arrow and Left Arrow buttons to advance and rewind the video.
 5. Press submenu  to move to **Video** list
-

FM Radio Mode

• FM Radio

1. To listen to the radio broadcast, select **FM Radio** in Main Menu.

Note: To set your **FM Radio Region: USA, Japan**, or **World** select **Radio Options** under **Settings** main menu.



-
2. When the radio frequency appears on the screen, press the Left or Right arrow to adjust and search for the desired frequency, or select preset by pressing Select. For fast search hold down the Left or Right arrow. You can browse other areas of the player, like Settings and Photos, while listening to the Radio.
-



• FM Preset

When Radio Mode is selected for the very first time, **Sansa e200** will run an auto station searching and store the searched stations as the preset favorite stations.

To set Radio options, press submenu  in **Radio** mode.

- Select **Add Preset** to save current frequency into presets.
 - Select **Delete Preset** to remove current frequency from presets.
 - Select **Delete All Preset** to clear all presets, and next time when you enter Radio Mode, **Sansa e200** will search automatically.
 - Select **View All Presets** to view all preset frequencies.
-



Recording Mode

• Voice Recording

Use your **Sansa e200** for Microphone Recording. You can record your own voice, an interview, or a speech via internal microphone.

1. Press the **Record** button to start recording.
2. To pause recording, select **Pause** in Record mode.

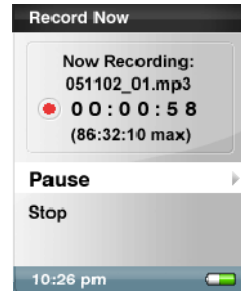

3. On the Display, a recording file should be generated and placed under the folder of [/RECORD/VOICE/].

4. To stop recording, select **Stop** in record mode, and then a pop-up window will appear on the screen. Select **Yes** to save recording. The recording will be saved in the **RECORD** folder. The file list will appear.

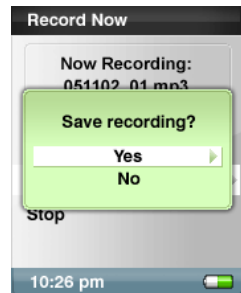

5. Press Left arrow to go to Record, Listen, or Delete Recording Menu.



• FM Radio Broadcast Recording

1. Select a radio broadcast channel that you want to record.
2. Press the **Record** button to start recording.
3. To pause recording, select **Pause** in Record mode.

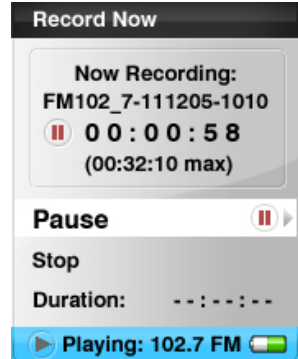

4. To set the duration of recording, select **Duration** and use the Thumbwheel to adjust the time. Press Select.

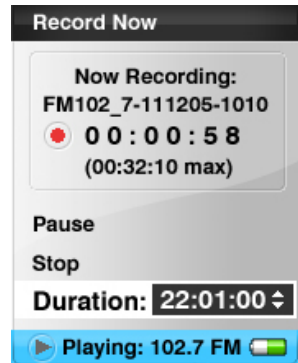

5. On the Display, a recording file should be generated and placed under the folder of [/RECORD/FM/].
-

-
- To stop recording, select **Stop** and the **Save Recording?** window will appear. Select **Yes** to save recording. It will be saved in the **RECORD** folder. The file list will appear.

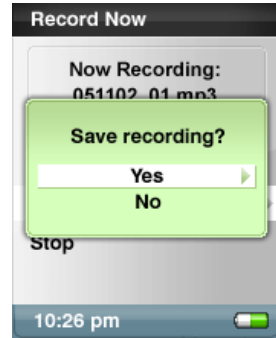

Settings Mode

You can personalize your Sansa e200 settings by selecting **Settings** in the main menu.

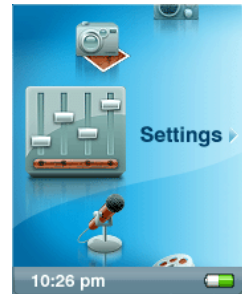

-
- Scroll the Settings Menu and make a selection.
-

- **Set Backlight**

Backlight timer program can adjust the backlight setting from the default, turn off backlight after 2 seconds idle time. Press any button to turn on the backlight.

1. Select **Settings** in Main Menu.
2. Select the **Backlight** item.
3. Select the Backlight **Off** setting that you want.

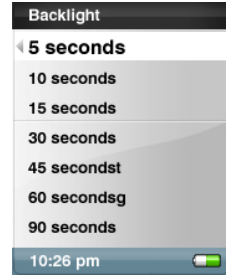

▪ Set Language

1. Select **Settings** in Main Menu.
2. Select the **Language** item.
3. Select a language you want to use.



▪ Set Date and Time

1. Select **Settings** in Main Menu.
2. Select the **Time** item.
3. Set the time or date.
4. Press the Left arrow for previous screen.



▪ Set Brightness

5. Select **Settings** in Main Menu.
6. Select the **Brightness** item.
7. Use the wheel to adjust the brightness setting, and then press Select to confirm and exit.

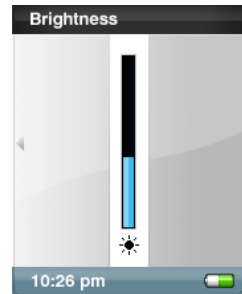

▪ Reset to Original Setting

1. Select **Settings** in Main Menu.
2. Select the **Reset** item.
3. Select the **Yes** item.

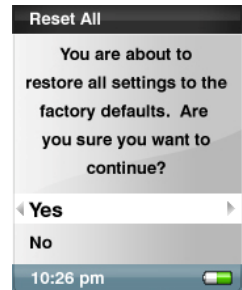

▪ Device Information

1. Select **Settings** in Main Menu.
2. Select the **Info** item.
3. You can read device information on the screen.

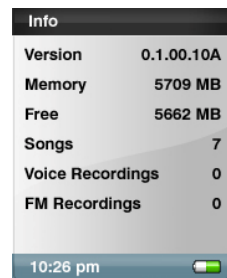

▪ Set Auto Shut-Off

1. Select **Settings** in Main Menu.
3. Select the **Auto Shut-Off** item.
4. Select the setting you want.



▪ Set USB Mode

1. Select the **Setting** item in Main Menu.
2. Select the **USB Mode** item.

You can select Auto Detect or MSC mode.

Note: MTP Media Player (MTP) mode

The MTP mode supports Windows Media Player 10 only. You must use the MTP mode to synchronize music files using Windows Media Player 10.

▪ Reset the Device

NOTE: THIS IS AN ADVANCED OPERATION.

NORMAL USERS ARE NOT

RECOMMENDED TO PERFORM THIS

OPERATION!

Sansa e200 provides a **Reset Function**. Please note that you only need to use this function if the device does not respond for several minutes. The button is like a power down button of the device. You can turn off the device by using a

reset operation, such as pressing and holding the **Menu** button for 15 seconds. Once you perform the reset function, the adjustments you made during last operation will be gone.

Tips, FAQ, and Troubleshooting

This chapter provides answers to common questions you may have.

Question: How do I copy files to the Sansa MP3 Player?

Answer: Copy files to the Sansa e200, in MSC mode, is just like copying files to a Hard Drive.

Question: What file formats does the Sansa e200 support?

Answer: The Sansa MP3 Player will support MP3, WMA, secure WMA. Any other formats need to be converted to these formats prior to transferring to your Sansa e200.

Question: What is MTP?

Answer: Media Transfer Protocol (MTP) is a new protocol and accompanying set of drivers developed by Microsoft to connect portable devices to a Windows XP PC and synchronize digital media content between those devices and the PC.

Question: Some of my music files are on my player, but cannot be played. When I select them, another song begins to play. What is wrong?

Answer: You may not have purchased the rights to play the song on an additional device. To test this, try to play a song that you have copied from an

older CD and converted to MP3 format. If you can play that song, but not the song that will not play, then you need to purchase the rights to play the song.

Question: Why should I update the firmware?

Answer: You should always update the player to the latest firmware to ensure that it functions correctly and has all the latest features.

Question: How do I access the player microSD card from computer?

Answer: There is no need to change any settings. To access the card from the computer, open up My Computer, and it should show up as Removable Disk.

Question: How can I use non-supported file types with my mp3 player?

Answer: First you must convert the songs to a supported format. Then you can transfer the songs to the player as normal, either by copying and pasting, or transferring.

Question: In MTP mode, how do I drag files to the player?

Answer: As long as the files are wma or mp3, they can be dragged into the Media folder. Otherwise, they can be dragged into the Data folder (these files will not appear on the player). An alternative is to switch the player to MSC mode, then the files can be dragged/copied to the root directory.

Question: Is the player compatible with podcasts?

Answer: As long as the podcasts are in mp3 format and an appropriate bit rate (32-320 kbps), then the player should be capable of playing the files.

Question: Why does my player say unknown artist/album?

Answer: Normally this is because the ID3 tags are missing information. On the computer, right-click the song and choose Properties, then the Summary tab and click Advanced. Then you can input the data such as Artist, Album, Song Title, Track Number, Genre, and Year.

Service and Warranty Information

This chapter provides information about how to get support for your player and the terms of your warranty.

Getting Technical Support

Before you contact Technical Support, we encourage you to read the **Tips, FAQ, and Troubleshooting** section.

If you have questions about the use or features of your player, please call the SanDisk Technical Support Center at 1-866-SanDisk (1-866-726-3475), or fill out an on-line support request at <http://www.sandisk.com/retail/support.asp>.

If you have questions about our partner services, please call their Technical Support Center.

When you call or contact us for support, please include as much information as you can from your packaging material. This will allow us to help you more quickly.

Learn More

You also can visit us on the web at <http://www.sandisk.com> to learn more about your player as well as other SanDisk products.

Your 1-Year SanDisk Limited Warranty

SanDisk warrants that this product will be free from material defects in design and manufacture and will substantially conform to the published specifications under normal use for one year from your date of purchase, subject to the conditions below. This warranty is provided to the original end user purchasing from SanDisk or an authorized reseller, and is not transferable. Proof of purchase may be required. SanDisk is not responsible for any failure or defect caused by any third party product or component, whether authorized or not. This warranty does not apply to any third party software provided with the product and you are responsible for all service and repair needed for such software. This warranty is void if the product is not used in accordance with the product instructions, or if it is damaged as a result of improper installation, misuse, unauthorized repair, modification or accident.

To obtain warranty service contact SanDisk at 1-866-SanDisk or send an email to: support@SanDisk.com. You must return the product in tamper resistant packaging, freight prepaid, as instructed by SanDisk. You must obtain a tracking confirmation number, which you may be required to provide to SanDisk. SanDisk will, at its option, repair or replace the product with new or refurbished product of equal or greater capacity and functionality, or refund the purchase price. The warranty duration on replaced product will be that time period remaining on the original product. THIS CONSTITUTES SANDISK'S ENTIRE LIABILITY AND YOUR EXCLUSIVE REMEDY FOR BREACH OF THIS WARRANTY.

SanDisk does not warrant, and shall not be responsible for, any lost data or information contained in any product (including in any returned product), regardless of the cause of the loss. SanDisk's products are not warranted to operate without failure. SanDisk products should not be used in life support

systems or other applications where failure could threaten injury or life. This warranty gives you specific legal rights, and you may also have other rights which vary by jurisdiction.

THE FOREGOING IS SANDISK'S SOLE WARRANTY. SANDISK DISCLAIMS ALL OTHER EXPRESS AND IMPLIED WARRANTIES TO THE FULLEST EXTENT PERMITTED BY APPLICABLE LAW. THE IMPLIED WARRANTIES OF MERCHANTABILITY AND FITNESS FOR A PARTICULAR PURPOSE ARE LIMITED TO THE DURATION OF THE EXPRESS WARRANTY. SOME JURISDICTIONS DO NOT ALLOW LIMITATION ON HOW LONG AN IMPLIED WARRANTY LASTS, SO THE ABOVE LIMITATION MAY NOT APPLY TO YOU. IN NO EVENT SHALL SANDISK OR ANY AFFILIATED OR SUBSIDIARY COMPANY BE LIABLE UNDER ANY CIRCUMSTANCES FOR ANY DIRECT, INDIRECT, OR CONSEQUENTIAL DAMAGES, ANY FINANCIAL LOSS OR ANY LOST DATA OR IMAGE, EVEN IF SANDISK HAS BEEN ADVISED OF THE POSSIBILITY OF SUCH DAMAGE. SOME JURISDICTIONS DO NOT ALLOW THE EXCLUSION OR LIMITATION OF INCIDENTAL OR CONSEQUENTIAL DAMAGES, SO THE ABOVE LIMITATION OR EXCLUSION MAY NOT APPLY TO YOU. IN NO EVENT WILL SANDISK'S LIABILITY EXCEED THE AMOUNT PAID BY YOU FOR THE PRODUCT.

SanDisk, the SanDisk logo, and Store Your World In Ours are trademarks of SanDisk Corporation, registered in the U.S. and other countries. Sansa, Trusted Flash, and gruvi are trademarks of SanDisk Corporation. SanDisk is an authorized licensee of the SD trademark. The PlaysForSure logo is a trademark or registered trademark of Microsoft Corporation in the United States and/or

other countries.

Liquidmetal is a registered trademark of Liquidmetal Technologies, Inc.

Other brand names mentioned herein are for identification purposes only and may be trademarks of their respective holder(s).

© 2006 SanDisk Corporation. All rights reserved.

Made in China

USER NOTICE:

This product is protected by certain intellectual property rights of Microsoft Corporation. Use or distribution of such technology outside of this product is prohibited without a license from Microsoft or an authorized Microsoft subsidiary.

Content providers are using the digital rights management technology for Windows Media contained in this device (“WM-DRM”) to protect the integrity of their content (“Secure Content”) so that their intellectual property, including copyright, in such content is not misappropriated. This device uses WM-DRM software to play Secure Content (“WM-DRM Software”). If the security of the WM-DRM Software in this device has been compromised, owners of Secure Content (“Secure Content Owners”) may request that Microsoft revoke the WM-DRM Software’s rights to acquire new licenses to copy, display and/or play Secure Content. Revocation does not alter the WM-DRM Software’s ability to play unprotected content. A list of revoked WM-DRM Software is sent to your device whenever you download a license for Secure Content from the Internet or from a PC. Microsoft, may, in conjunction with such license, also

download revocation lists onto your device on behalf of Secure Content Owners

End User License Agreement

SANDISK CORPORATION

END USER LICENSE AGREEMENT

DO NOT USE OR LOAD THIS SOFTWARE until you have carefully read the following terms and conditions. The firmware, computer programs, device drivers, data or information (“Software”) distributed or bundled with the product is provided to you under the terms and conditions of this End User License Agreement, and may be subject to additional terms and conditions in an agreement between you and SanDisk’s third party licensors. By downloading, installing or using the accompanying Software, you agree to all of the terms of this End User License Agreement between SanDisk Corporation (“SanDisk,” “we,” or “us”) and each person who downloads, installs or uses the Software (“you” or “your”). The Software is owned by SanDisk or by others including Portal Player Inc. (“Licensors”) who permit SanDisk to distribute their Software. If you do not agree to the following terms and conditions, do not install or use the Software. The Software is protected by copyright laws and international copyright treaties, as well as other intellectual property laws and treaties.

1. Software License. Subject to the terms and conditions contained herein, SanDisk grants to you a limited, non-exclusive, non-sublicensable, transferable in accordance with these terms, royalty-free right and license under SanDisk's intellectual property rights to use the Software in executable form for SanDisk products and services solely for your personal use on a single computer (the "License"). For each Software licensee, the Software can be "in use" on only one computer or hardware device at any given time. The Software is "in use" when it is either downloaded, copied, loaded into RAM or installed into the hard disk or other permanent memory of a computer or other hardware device. SanDisk and its Licensors retain all right, title and interest in and to the Software.
2. Restrictions. SanDisk or its Licensors retain all rights in the Software not expressly licensed to you. You may not modify, create derivative works (new versions) of, adapt or translate the Software. No source code is provided under this Agreement. You may not reverse engineer, disassemble, decompile, rent, or lease the Software, or re-create or discover the source code version of the Software. The Software contains proprietary and confidential information of SanDisk or its Licensors, which you agree not to discover or reveal to others. Any and all permitted copies of the Software that you make or distribute must be unmodified, must contain all of the original Software's proprietary notices, and must include or be accompanied by this Agreement. You may not separate the Software into

component parts for sublicense, distribution or transfer to a third party. You may not embed the Software within any other software product or modify the Software in whole or in part in any manner.

3. DISCLAIMER OF WARRANTIES. TO THE MAXIMUM EXTENT PERMITTED BY APPLICABLE LAW, THE SOFTWARE IS PROVIDED “AS IS” AND “AS AVAILABLE” WITH NO WARRANTIES. NEITHER SANDISK NOR ITS LICENSORS MAKE ANY REPRESENTATION OR WARRANTY, STATUTORY OR OTHERWISE, IN LAW OR FROM THE COURSE OF DEALING OR USAGE OF TRADE, EXPRESS OR IMPLIED, INCLUDING WITHOUT LIMITATION ANY WARRANTIES OF MERCHANTABILITY, FITNESS FOR A PARTICULAR PURPOSE, NON-INTERFERENCE, OR NON-INFRINGEMENT OF ANY THIRD PARTY INTELLECTUAL PROPERTY RIGHTS, OR EQUIVALENTS UNDER THE LAWS OF ANY JURISDICTION. YOU ASSUME THE ENTIRE RISK AS TO THE QUALITY AND PERFORMANCE OF THE SOFTWARE. SHOULD THE SOFTWARE PROVE DEFECTIVE, YOU, AND NOT SANDISK, ITS LICENSORS OR RESELLERS, ASSUME THE ENTIRE COST OF NECESSARY SERVICING, REPAIR, OR CORRECTION.
4. LIMITATION OF LIABILITY. IN NO EVENT WILL SANDISK OR ITS LICENSORS, OR THEIR RESPECTIVE DIRECTORS, OFFICERS, EMPLOYEES, CONSULTANTS,

LICENSORS, LICENSEES OR AFFILIATES, BE LIABLE FOR ANY INDIRECT, INCIDENTAL, SPECIAL, CONSEQUENTIAL, OR EXEMPLARY DAMAGES, ARISING OUT OF OR IN CONNECTION WITH THE DOWNLOAD, USE OR PERFORMANCE OR NON-PERFORMANCE OF THE SOFTWARE. THE FOREGOING LIMITATIONS OF LIABILITY SHALL APPLY NOTWITHSTANDING ANY FAILURE OF ANY REMEDY PROVIDED FOR HEREUNDER IN ITS ESSENTIAL PURPOSE. IN NO EVENT WILL SANDISK'S OR ITS LICENSORS' TOTAL LIABILITY TO YOU EXCEED THE AMOUNT YOU PAID TO US FOR THE USE OF THE SOFTWARE.

5. The Software is provided with "RESTRICTED RIGHTS." Use, duplication or disclosure by the Government is subject to restrictions as set forth in FAR 52.227-14 and DFARS 252.227-7013 et seq. Use of the Software by the Government constitutes acknowledgement of SanDisk's proprietary rights therein. Contractor or Manufacturer is SanDisk Corporation, 140 Caspian Court, Sunnyvale, CA 94089.
6. Termination. We may terminate this Agreement and the license if you violate this Agreement at any time. Upon termination of this Agreement, you must delete or destroy all copies of the Software.
7. High Risk Activities. The Software is not fault-tolerant and is not designed or intended for use in hazardous environments requiring fail-safe performance, or any other application in

which the failure of the Software could lead directly to death, personal injury, or severe physical or property damage (collectively, "High Risk Activities"). SANDISK DISCLAIMS ANY EXPRESS OR IMPLIED WARRANTY OF FITNESS FOR HIGH RISK ACTIVITIES AND SHALL NOT BE LIABLE FOR ANY LIABILITIES OR DAMAGES ARISING FROM SUCH USE.

8. General. This Agreement contains the entire understanding between the parties with respect to your use of the Software. If any part of this Agreement is found void and unenforceable, it will not affect the validity of the balance of this Agreement, which shall remain valid and enforceable according to its terms. This Agreement is governed by and construed under the laws of the State of California and the Federal laws of the United States of America without regard to conflicts of laws provisions thereof. The U.N. Convention on Contracts for the International Sale of Goods shall not apply to this Agreement. Any action or proceeding arising from or relating to this Agreement shall be adjudicated in the state or federal courts of Santa Clara County, California, and the parties hereby agree to the exclusive jurisdiction and venue of such courts. You will not remove or export from the United States or reexport from anywhere any part of the Software or any direct product thereof to any country in violation of U.S. Export Administration Regulations, or a successor thereto, or otherwise except in compliance with and with all licenses and approvals required under applicable export laws and

regulations including, without limitation, those of the U.S. Department of Commerce. Any waivers or amendments of this Agreement shall be effective only if made in writing and signed by an authorized representative of each party. The provisions of Sections 3, 4, 5, 6, 7 and 8 shall survive the termination or expiration of this Agreement.